



THE INDUSTRY LEADER

L.A.I. Group has over thirty years of experience producing and delivering high quality security products. On the following pages you will find one of the largest arrays of plug locks, cam locks, padlocks and security hardware in the world. This catalog contains L.A.I.'s security "Series 600" locks. If you don't find what you need, call us toll-free. We have many other non-standard pieces in inventory, and can custom fabricate for you right in our Southern California facility.

Before ordering, please take a minute to review these guidelines.

Locks:

- Specify type: ✓ Cam Type,
 ✓ T-Handle, or
 ✓ Padlock

For Keyed Alike Locks:

Specify if you want to maintain an existing key code series or start a new one.

If you want to match locks from another manufacturer, specify the brand and model. Usually we can match Fort, ACE, ESD, Baton and many others.

Hasps:

We provide hasps for all L.A.I. Padlocks. Some hasps may require some minor installation modifications. All L.A.I. hasps will accommodate any size padlock with shackle diameter of 9/16" or less.

See L.A.I.'s security hardware catalog for specifics.

Cams:

Please refer to the chart on page 7 for a complete guide to cams in the catalog. If you do not see what you need, call us. We can manufacture a custom piece to your specifications. Minimum quantities may be required for custom orders.

SERIES 600 CATALOG



Restricted Key Profiles & Dimensional Information..... 1



High Security Padlocks 2-3



New Millennium Locks 4-5



Cam Locks, Plug Locks & Accessories Ordering Guide 6-7



High Security Hasps..... 8-10



T-Handles..... 11

Lock America International, Inc.

dba. L.A.I. Group
 9168 Stellar Court
 Corona, California 92883

Tel: 951.277.5180

Fax: 951.277.5170

Toll Free: 800.422.2866

Toll Free Fax: 888.422.2866

Website: <http://www.laigroup.com>

E-Mail: sales@laigroup.com

Offices are located in:
 California • Massachusetts
 Mexico • Australia • Taiwan • United Kingdom

Lock America's Warranty

L.A.I. Group warrants, to the original purchaser, that all of its locks will be free of manufacturing defects (changes in appearance due to oxidation or normal discoloration excluded) for a period of 7 (seven) years from the date of purchase. L.A.I. Group will not assume any liability for any consequential loss or damages.

SERIES 600 CATALOG

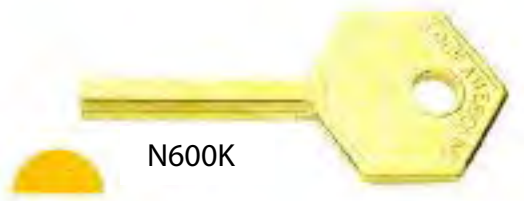

N600K



N601K



N602K



N603K - Right

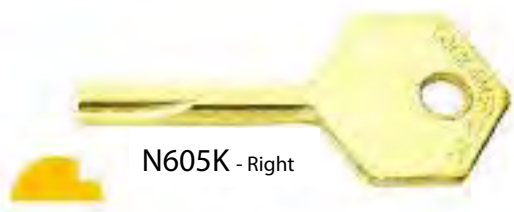

N605K - Right



N603K - Left

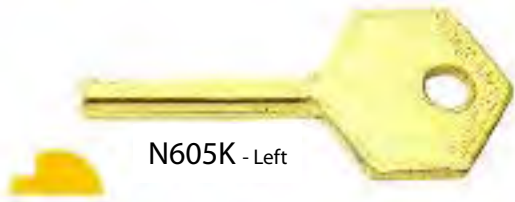

N605K - Left



N613K - Right
Keybows available in
either black or blue



N604K

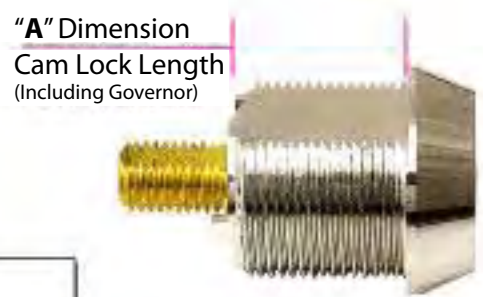
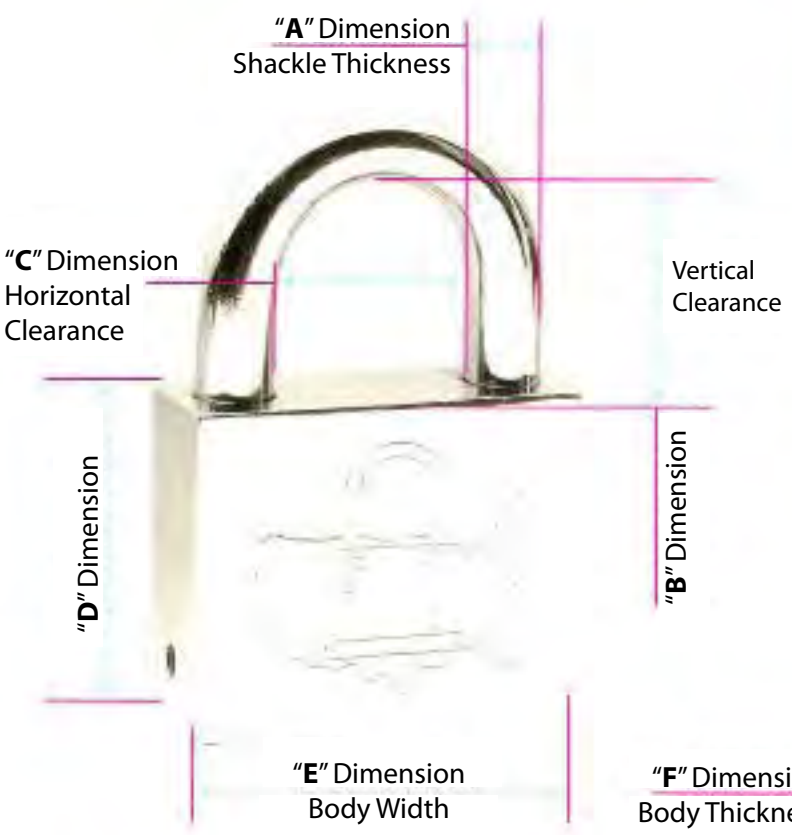

Lock America measures primarily in millimeters (1" = 25.4mm) • All locks shown at approximate actual size.

LOCK BREAKDOWN

- A = Shackle - available in Hardened or Brass Alloy Steel
- B = Body - available in Brass or Steel with Chrome Plating
- C = Stainless Steel Ball Bearings
- D = Spring for Disc Carrier
- E = Hardened Steel Locking Bar
- F = Disc Carrier
- G = Inner Discs and Spacers
- H = Hardened Steel Back Cover
- I = Stainless Steel Set Screw

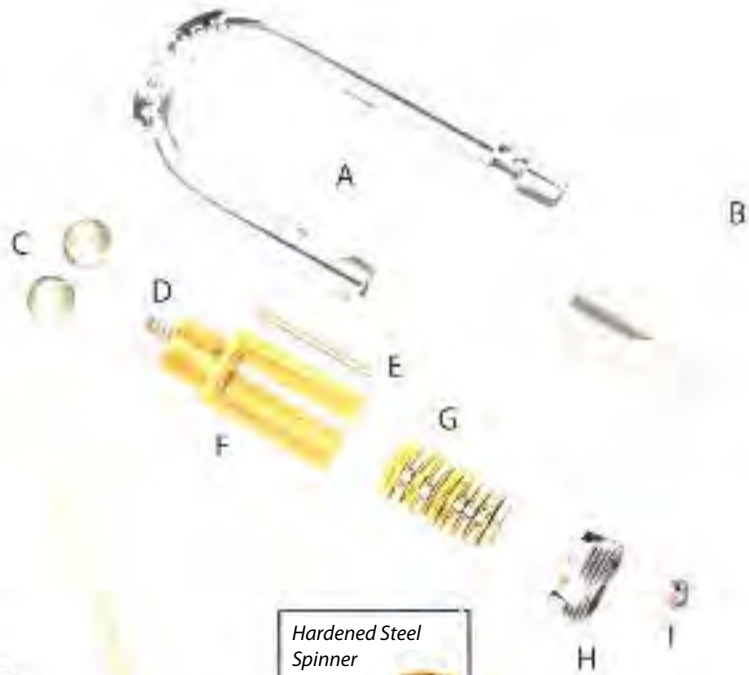

*Hardened Steel
Spinner
disc to
help
prevent
drilling.*



B630C
9" and 6"
Cable
Lengths

15" Cable

B630C
30mm Solid Brass Body,
2.5mm Thick Plastic
Coated Steel Cable

*Available in 3
lengths, 15, 9
and 6 inch.*

S655A"/B"	55mm Wide Hardened Steel, Chrome Plated Body & 11mm Thick Hardened Steel Shackle
S655B-2	Optional 2" Shackle Available Upon Request. Baron Alloy Shackle Only.
B655A"/B"	55mm Wide Solid Brass, Chrome Plated Body & 11mm Thick Hardened Steel Shackle.
B655B-2	Optional 2" Shackle Available Upon Request. Baron Alloy Shackle Only.
B655M	55mm Wide Solid Brass Chrome Plated Body & 11mm Thick Hardened Steel Shackle
B645A"/B"	45mm Wide Solid Brass, Chrome Plated Body & 9mm Thick Hardened Steel Shackle.
B645B 2	Optional 2" Shackle Available Upon Request. Baron Alloy Shackle Only.
B630C	30mm Solid Brass Body, 2.5mm Thick Plastic Coated Steel Cable Available in 3 Cable Lengths, 6" - 9" & 15".
B640A	40mm Solid Brass Body. 7mm Thick hardened Steel Shackle.
B630A	30mm Solid Brass Body. 5mm Thick hardened Steel Shackle.
S670D	70mm Solid Brass Body. 10mm Thick hardened Steel Shackle.
B671H	Replacement Inner Cylinder for S670D Padlock

*A = Hardened Steel Shackle
B = Baron Alloy Shackle - *Special Order Item*

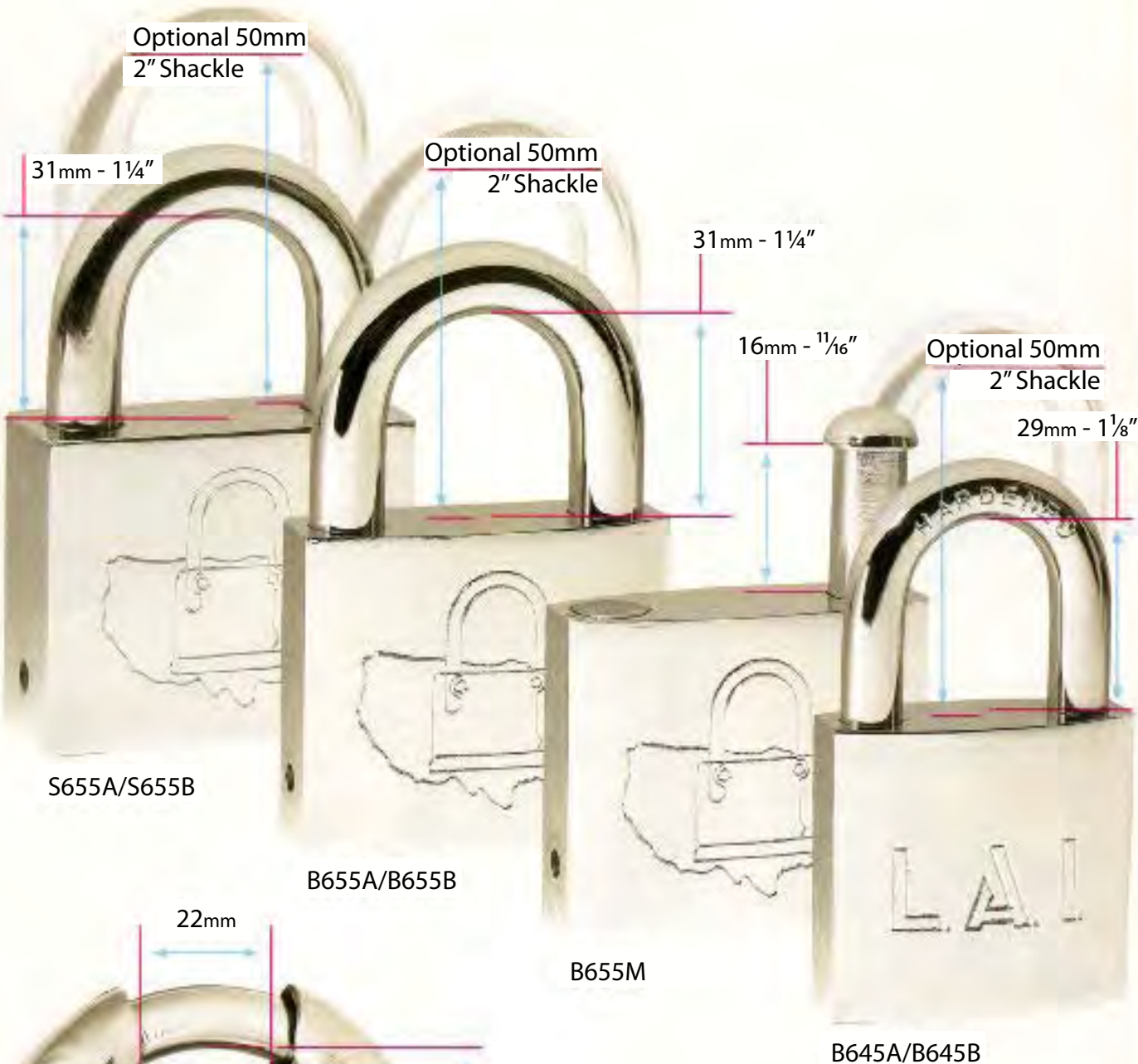



S673F

S673A/F
73mm Solid Steel Body Padlock with
Stainless Steel Outer Slip Ring
(A = Offset Back F = Flat Back)

**S673AN
Front**

S673AN

73mm Solid Steel Body Padlock with
Beveled Face (No Slip Ring)
(A = Offset Back F = Flat Back)



S673A - Rear View

This model is not equipped with a slip ring



S673F
S673AN - Core

S673F - Open



S673AN - Closed



S673F - Side View



S674A/F

73mm Solid Steel Body Padlock equipped with Anti Drill Cylinder Lock Core & Stainless Steel Outer Slip Ring (A = Offset Back F = Flat Back)



S674F Rear View

S674A

S674A Rear



S674F Open



S674F Side View



S674F Hardened Steel Core



S683F - Side View



S683F - Face



S683F - Rear View



S683F Open



S683F Core

S683F

78mm Solid Steel Body Padlock equipped with Hidden Anti Drill Cylinder Lock Core & Stainless Steel Outer Slip Ring (A = Offset Back F = Flat Back)



Front View

B618B



"A" Dimension: 5/8"

B622F



"A" Dimension: 7/8"

B629F



"A" Dimension: 1-1/8"

B618B - 18mm Camlock

*This model also available with hardened Steel Housing (S618A)

B622F - 22mm Camlock

B629F - 29mm Camlock

B639F - 40mm Camlock

B636F - 36mm Momentary

Switch Lock

B639F



"A" Dimension: 1-1/2"

B636F



"A" Dimension: 1-1/2"

Above Camlocks shown are available in both Left & Right Hand Turn and 90° or 180° Turn.

Also available:

- Finger Style Lock Washers
- Nylon Nut
(Eliminates need for Lock Washer)

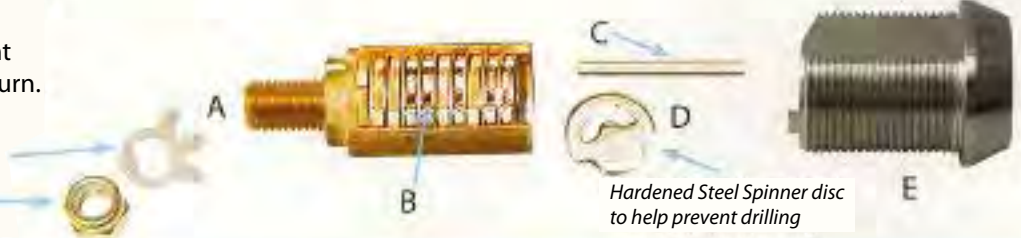

Hardened Steel Spinner disc to help prevent drilling



S619A/B

Front View



Side View

rounded face helps prevent against drilling



S619D/F

Front View



Side View



S833H



S833H With S619S

(Sold Separately)



Side View

S619A/B* High Security T-Handle Lock. Solid Hardened Steel Housing with 1/4" (6mm) thick rounded face to help prevent against drilling.
This lock meets N.A.M.A. Specifications.

S619D/F* High Security T-Handle Lock. Solid Steel Housing with 1/8" (3mm) thick face to help prevent against drilling.
This lock meets N.A.M.A. Specifications.

* B & F = Spring Action Latch,
A & D = Deadbolt Action Latch (Please Specify)

S833H Hardened Steel Housing for "Removable Core" Plug Lock.

S619S (Short Body) High Security "Removable Core" Plug Lock.
This lock meets N.A.M.A. Specifications.

B620F High Security Push Lock

B620F

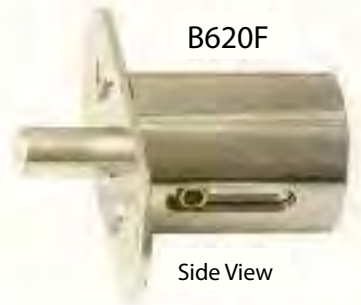

Side View



CUSTOM LENGTHS CAN BE SPECIAL ORDERED

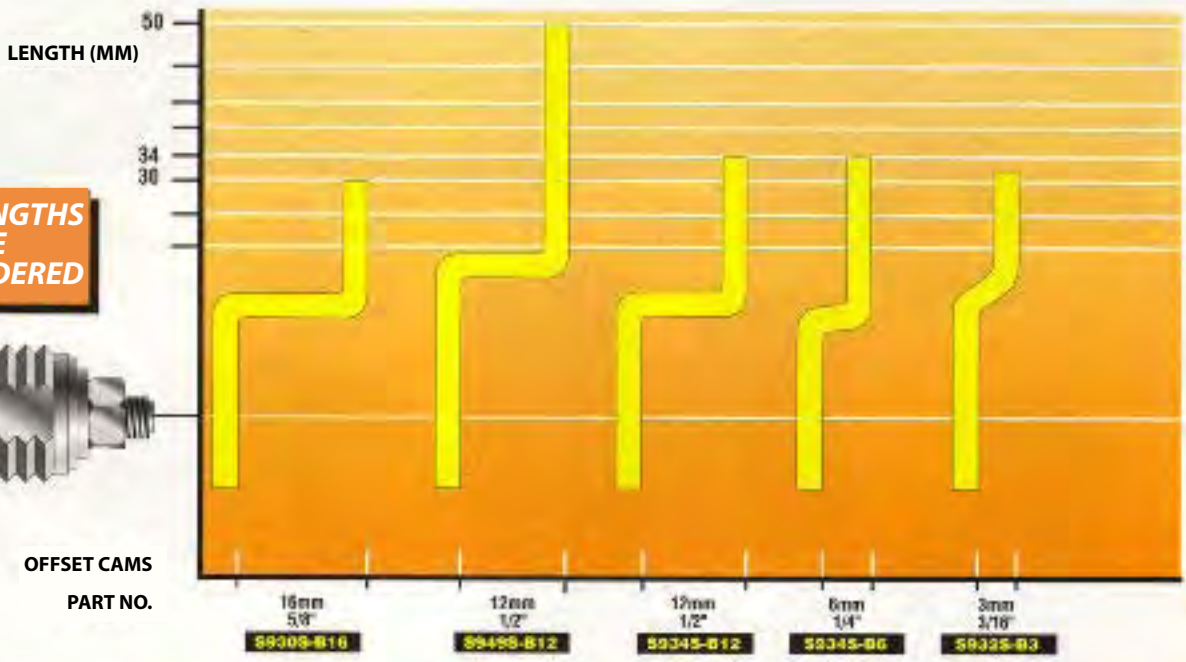

PART NO.	OUTER DIAMETER	INNER DIAMETER	HEIGHT	FLATS	MATERIAL	FINISH
98215	1-1/8"	3/4"	1/4"	2	Steel	Nickel
98235	1-1/16"	3/4"	1/8"	0	Steel	Nickel
98245	7/8"	3/4"	1/8"	0	Steel	Nickel
98225	1-1/8"	3/4"	1-1/16"	2	Steel	Nickel
98255	1-3/16"	3/4"	1/4"	0	Hardened Steel	Chrome
98265	1-3/16"	3/4"	3/8"	0	Brass	Chrome

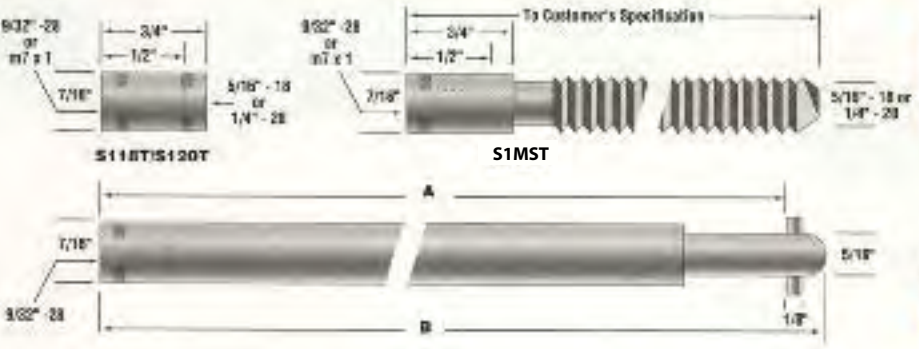

PART NO.	A DIMENSION	B DIMENSION
S112T	4-3/4"	5"
S121T	8-3/16"	8-7/16"
S130T	11-1/2"	11-5/8"
(See Insert)	12-5/16"	13-5/8"

Shaft can be used for both lengths.



Lock America measures primarily in millimeters (1" = 25.4mm) • All locks shown at approximate actual size

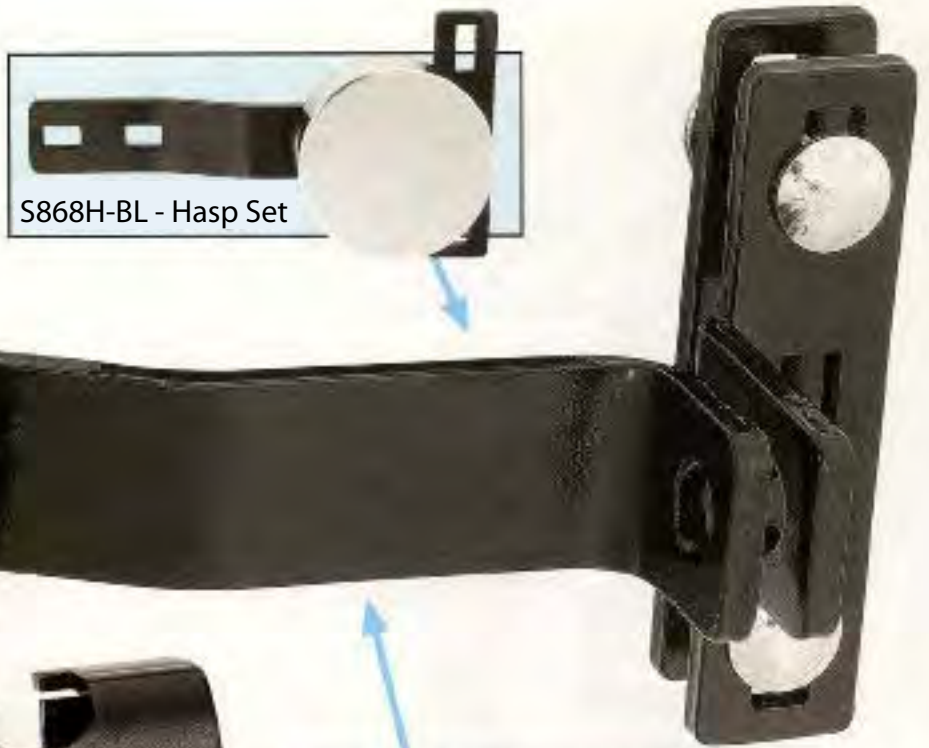

S868H-BL - Hasp Set



S868H-MH
Mounting Hardware - *Sold Separate

S868H-CC
Hardened Steel
Hardened Cover - *Sold Separate



Different Profiles to Accomodate Most Manufacturers

S868H-R
S868H
S868H-D



S868H-PC
Hasp Set With
Padlock Cover
**Made to use with Shackle style padlocks



S869H - Hasp Set
With Shroud Protection



BFL-6-46 - Hardened Steel
Hasp Set

Made to be used
with "A" style locks Only.



S820T - Hasp Set
special application

Accommodates Puck Style
Locks Located On Pages 4-5

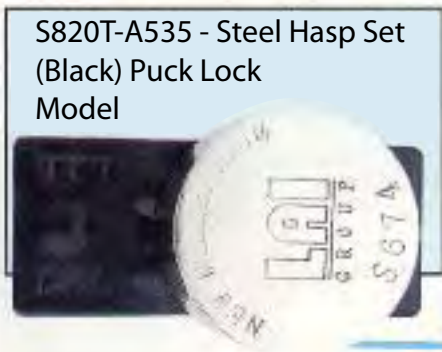
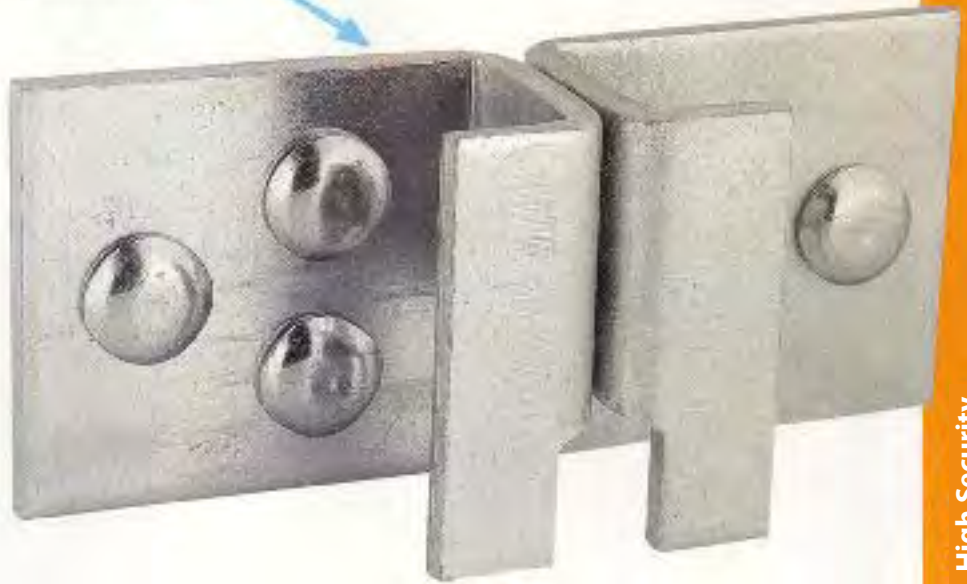

High Security Hasps

All Lock America T-Handles are equipped with Hardened Steel anti-drill roll pins to protect against drilling.



C865H-360

C865H-360
T-Handle Screw Type
(Meets N.A.M.A Specifications)



C865H-090

C865H-090
T-Handle Quarter Turn
(Meets N.A.M.A Specifications)



C834H-090

C834H-090
T-Handle Quarter Turn
(Short Model 11/16")



C832H-090-BLK

C832H-090-BLK
T-Handle Quarter Turn
(Short Model 11/16") "Black"



T-Handle
Locks